

Installation between brickwork (example with door opening towards inside)

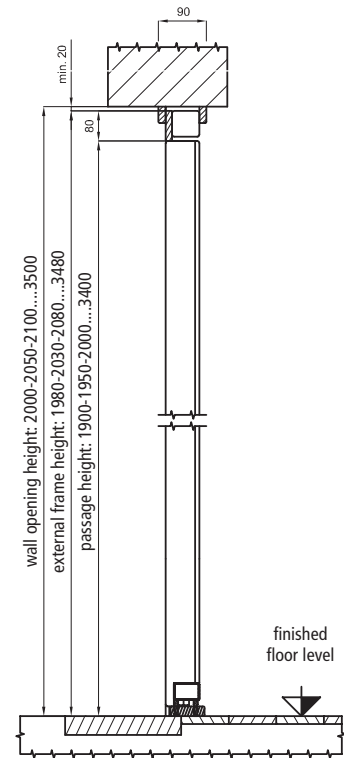

Installation behind brickwork (example with door opening towards inside)

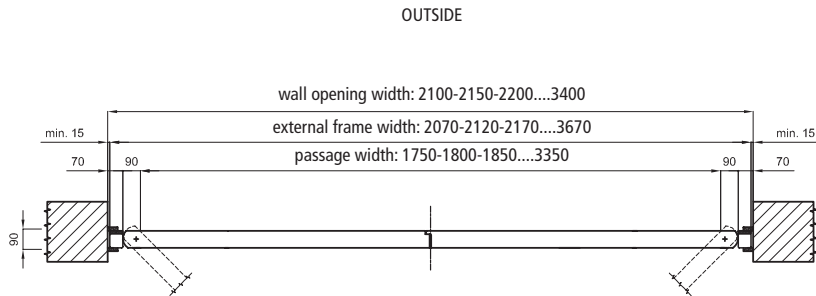
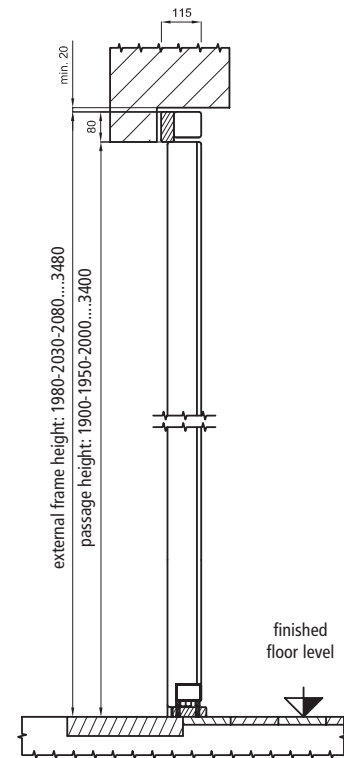
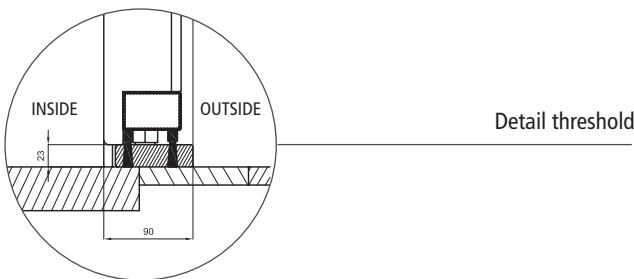
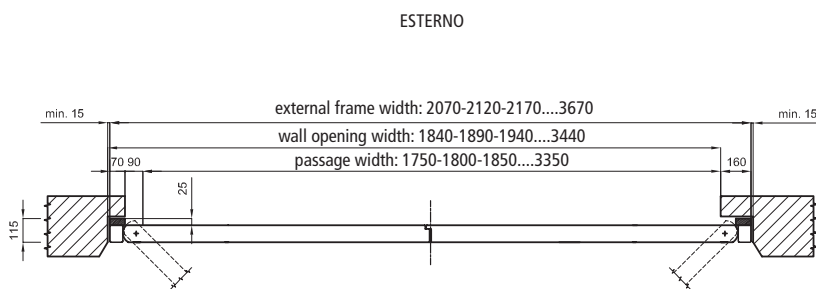

Table heights pedestrian door (mm)

DOOR H (mm)	2380	2430	2480	2530	2580	2630	2680	2730	2780	2830	2880	2930	2980	3030	3080	3130	3180	3230	3280	3330	3380	3430	3480	
H opening pedestrian door	FOR, VIP, DOC	1889	1939	1989	2039	2089	2139	2189	2239	2089	2139	2189	2239	2089	2139	2166	2239	2089	2116	2189	2239	2089	2141	2189
	OLD 250 mm	/	/	/	/	1994	2044	2094	2144	2194	1994	2044	2094	2144	1994	2044	2094	2144	2194	1994	2044	2094	2144	2144
K = H opening pedestrian door + 72	FOR, VIP, DOC	/	/	/	/	2161	2211	2261	2311	2161	2211	2261	2311	2161	2211	2238	2311	2161	2188	2261	2311	2161	2213	2261
	OLD 250 mm	/	/	/	/	2066	2116	2166	2216	2266	2066	2116	2166	2216	2266	2066	2116	2166	2216	2266	2066	2116	2166	2216

Table application motor type L or type S

DOOR NOMINAL WIDTH (mm)		2070	2120	2170	2220	2270	2320	2370	2420	2470	2520	2570	2620	2670	2720	2770	2820	2870	2920	2970	3020	3070	3120	3170	3220	3270	3320	3370	3420	3470	3520	3570	3620	3670
WITH PEDESTRIAN DOOR	DOC, VIP	L	L	L	L	L	L	S	S	S	S	S	S	S	S	S	S	S	S	S	S	S	S	S	S	S	S	S	S	S	S	S	S	S
	FOR, OLD, SPI	L	L	L	L	L	L	S	S	S	S	S	S	S	S	S	S	S	S	S	S	S	S	S	S	S	S	S	S	S	S	S	S	S
	BIG, EGO	L	L	L	L	L	L	S	S	S	S	S	S	S	S	S	S	S	S	S	S	S	L	L	L	L	L	L	L	L	L	L	L	L
WITHOUT PEDESTRIAN DOOR	BIG, EGO, FOR, OLD, SPI	S	S	S	S	S	S	S	S	S	S	S	S	S	L	L	L	L	L	L	L	L	L	L	L	L	L	L	L	L	L	L	L	L
	DOC, VIP	S	S	S	S	S	S	S	S	S	S	S	S	S	S	S	S	S	S	S	S	S	S	S	S	S	S	S	S	S	S	S	S	S

Table motor sizes type L or type S

TYPE L	A	B	C	D	E	K
		720	8	104	129	900

TYPE S	A	B	C	D	E	K
		920	78	159	184	1100

Installation between brickwork (horizontal section)

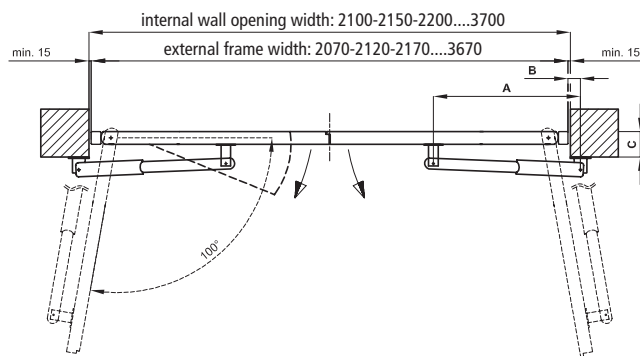

For all installation types (vertical section)

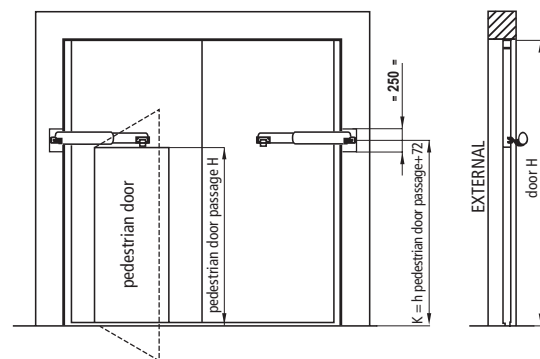

Installation behind brickwork with thickening boards (horizontal section)

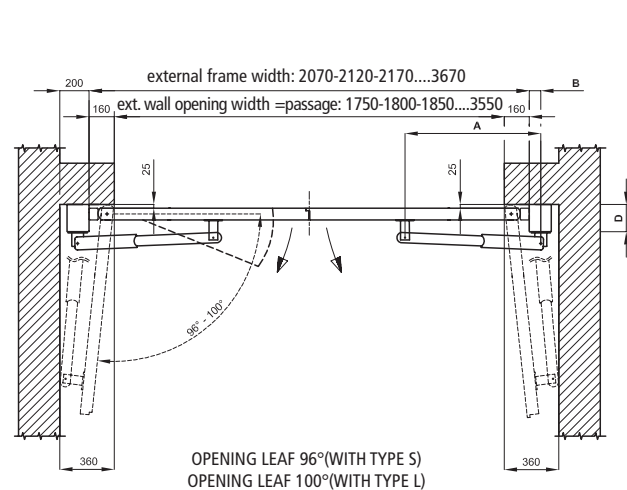

Installation between brickwork with recess for motorisation (horizontal section)

